

Part Location

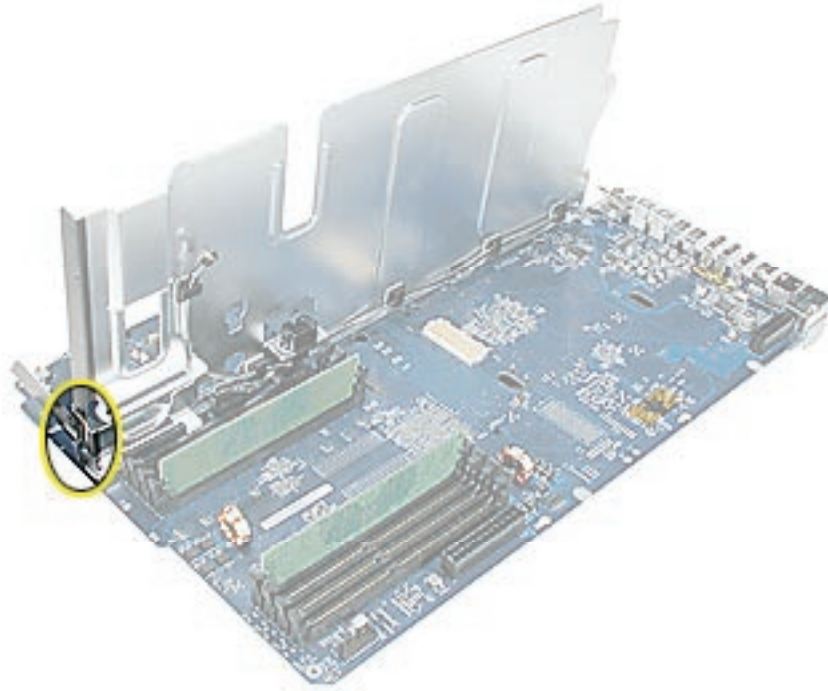

Procedure

1. Disconnect the thermistor cable from the logic board.
2. Remove the thermistor cable from the guide on the PCI divider.

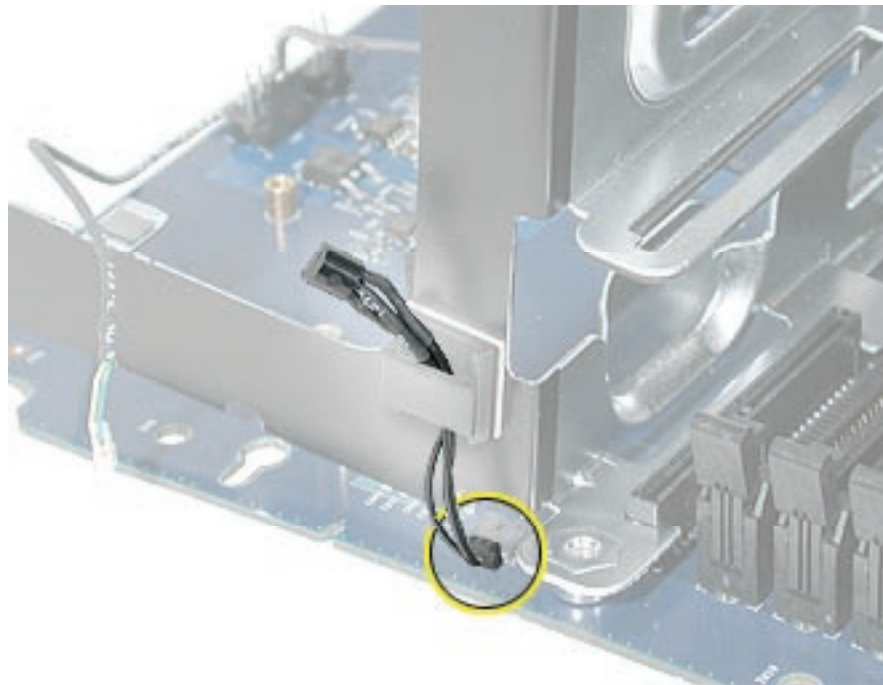



Ambient Board: Power Mac G5 (June 2004 Dual 2.0/2.5 GHz), Power Mac G5 (Early 2005 Dual 2.3/2.7 GHz)

Tools

No tools are required for this procedure.

Preliminary Steps

Before you begin, open the computer and lay it on its side with the access side facing up.

Part Location

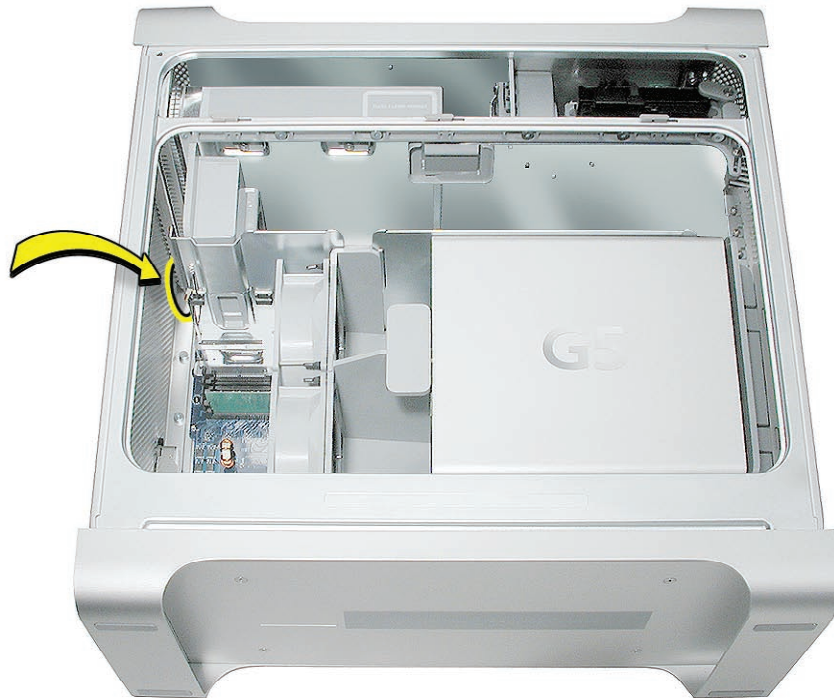

Procedure

1. Locate the ambient board next to the speaker/fan assembly.

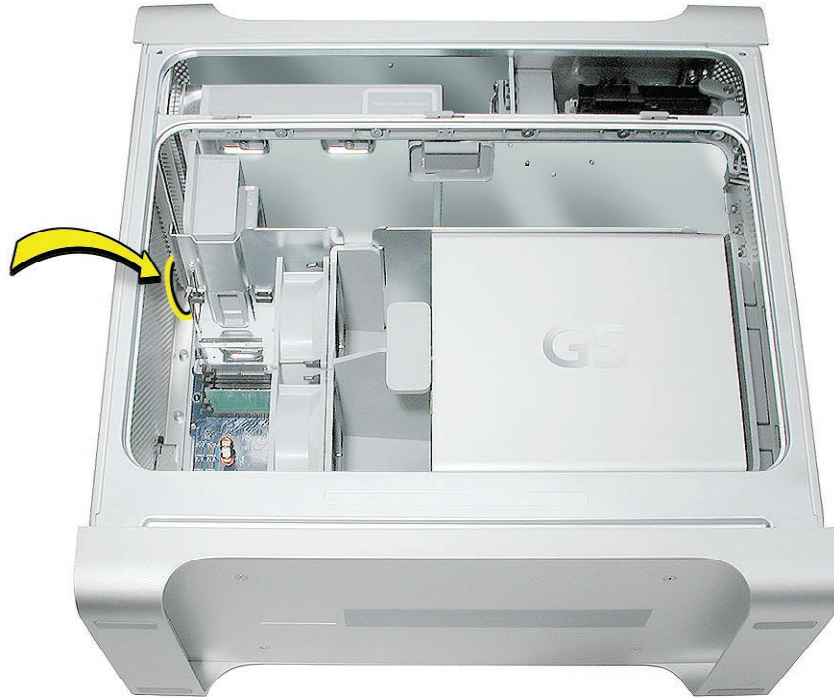

2. Lift the speaker/fan assembly straight up to disengage the large tab (circled) on the side of the bracket from the channel in the sheet metal.

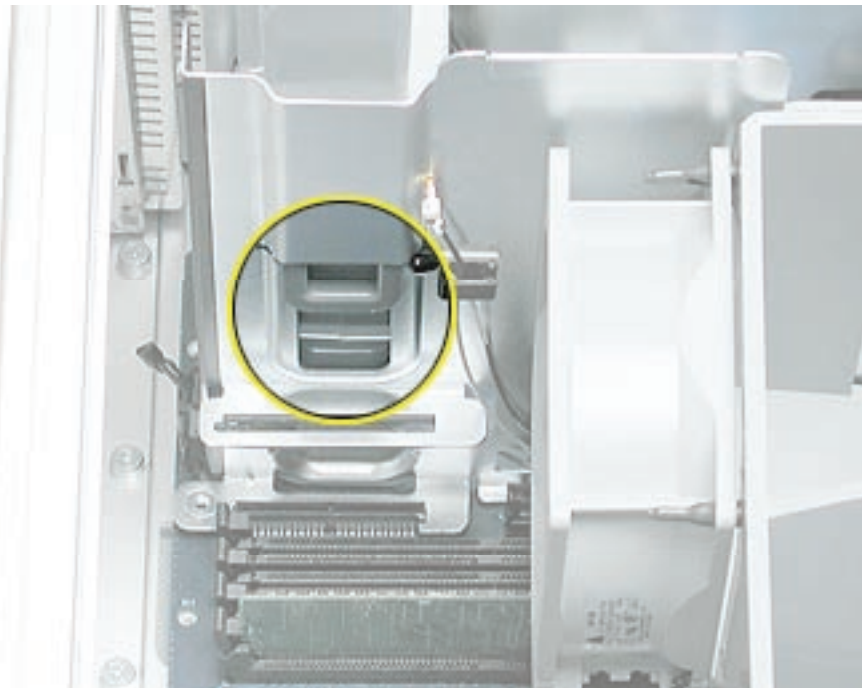

3. Set the speaker/fan assembly off to the side; there is no need to disconnect the assembly.

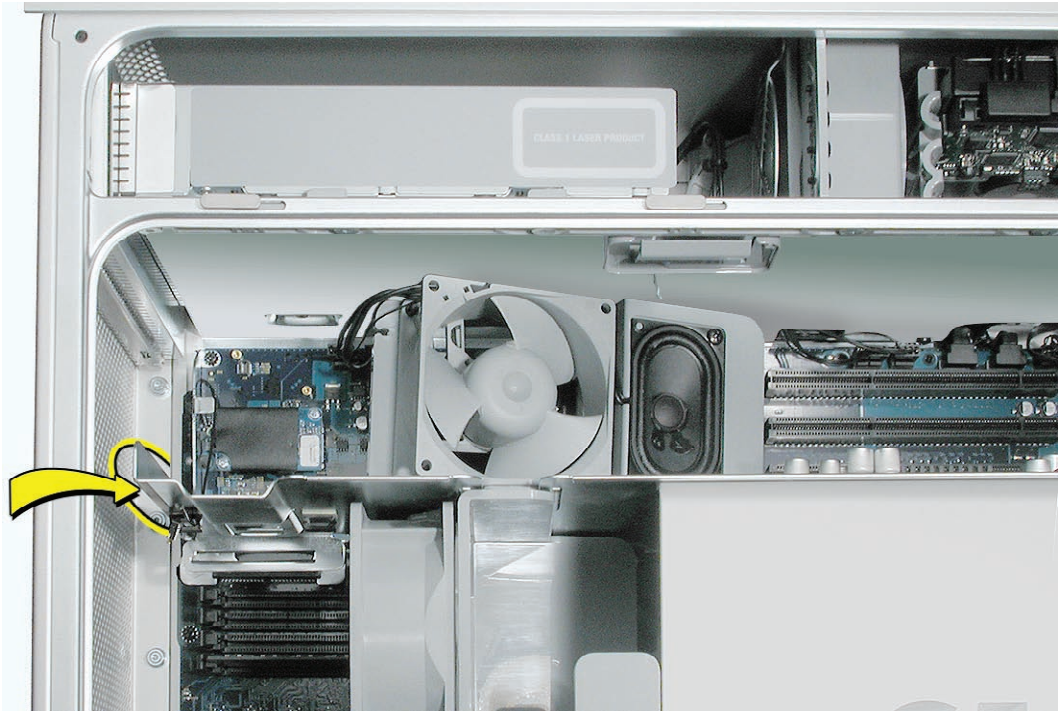

4. Locate the ambient board connected to the logic board.

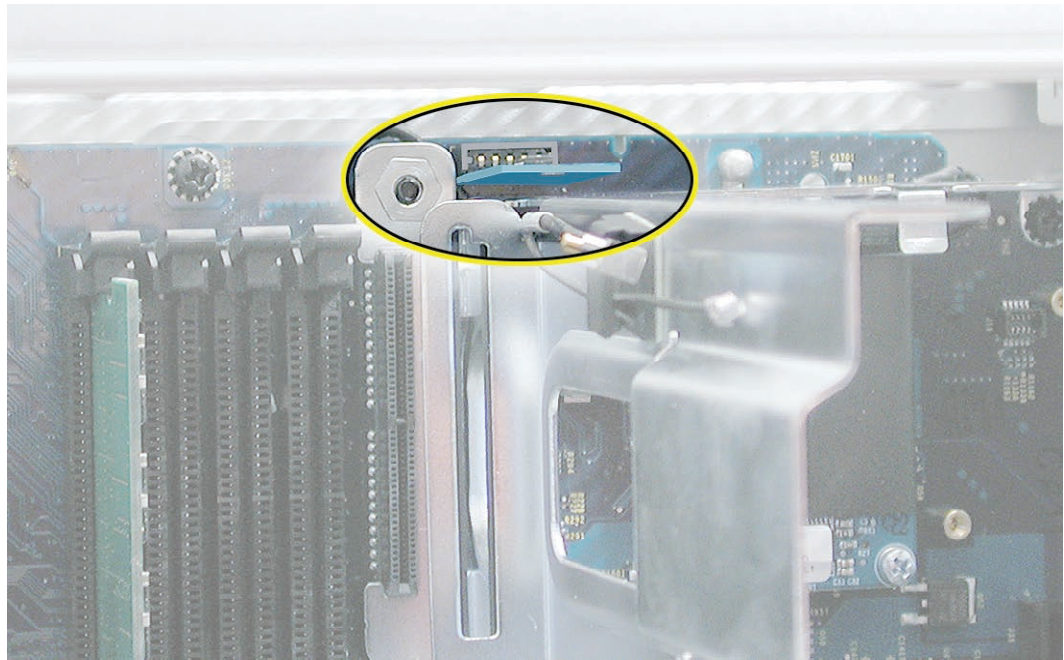

-
5. Position your fingers on both sides of the board. Gently rock the board from side-to-side, pulling it straight up and out of the connector.

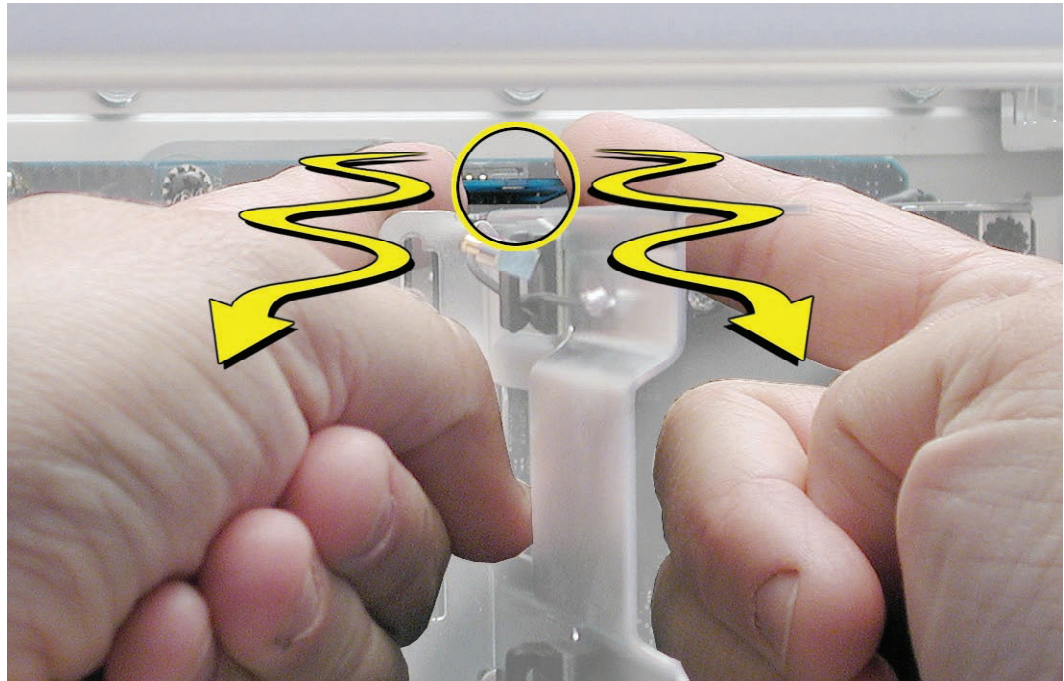



Front Inlet Fan Cable

Tools

The only tools required for this procedure are a long-handled Phillips screwdriver, a short-handled Phillips screwdriver, and a hex wrench.

Preliminary Steps

Before you begin, open the computer, lay it on its side with the access side facing up, and remove the following:

- [Front inlet fan assembly](#)
- [Heatsink cover\(s\) for Power Mac G5](#) or
- [Heatsink cover\(s\) for Power Mac G5 \(June 2004/Early 2005\)](#)
- [Processor\(s\) for Power Mac G5 without LCS Heatsink](#) or
- [Processor for Power Mac G5 with LCS Heatsink](#)
- [All AGP and PCI cards](#)
- [Rear exhaust fan assembly](#)
- [PCI card guide](#)
- [Speaker/fan assembly](#)
- [Front panel board cable](#)
- [Memory DIMM](#) if it is in slot next to the power supply cable
- [Power supply for Power Mac G5 without LCS Heatsink](#) or
- [Power supply for Power Mac G5 with LCS Heatsink](#)
- [Logic board for Power Mac G5](#) or
- [Logic board for Power Mac G5 \(June 2004/Early 2005\)](#)
- [PCI divider](#)